

# ALBED

MILANO 1964

Suit



La tua soluzione  
online su [albed.it](http://albed.it)

Il sistema prodotto / 4

Suit / 6

Dettagli tecnici / 18

Boiserie / 24

Finiture / 28

La missione di Albed

**ESSERE IL MIGLIORE  
INTERPRETE  
DELLE SOLUZIONI  
TECNICHE  
PER L'ARCHITETTURA  
DI INTERNI.**

Albed's mission

**TO BE THE BEST  
EXPONENTS  
OF TECHNICAL  
SOLUTIONS  
FOR INTERIOR  
ARCHITECTURE.**

## Il sistema prodotto

Un sistema completo di soluzioni tecniche al servizio del progettista.

Abbiamo ripensato il percorso di scelta del prodotto, secondo le esigenze progettuali e la nuova mission aziendale: esserne il migliore interprete. Abbiamo tracciato questo percorso in tre domande che propongono un nuovo approccio alla definizione della porta.

Come la porta si apre?  
Come la porta si integra nel progetto?  
Quale estetica e performance presenta il pannello?

## The product system

A complete system of technical solutions, serving the designer.

We have rethought the path of choosing the product, according to the design needs and the new company mission: to be the best interpreter. We have traced this path following three questions that propose a new approach to defining the door.

How does the door open?  
How does the door integrate into the project?  
What aesthetics and performance does the panel have?



# Suit

Design / Design by: CRS Albed

Tipologia / Typology: Porta battente | Hinged door

**Un sistema di porte filomuro con alto grado di configurabilità al servizio del progettista.**

Suit è un sistema di porte caratterizzato da una cornice in alluminio quasi invisibile che permette di rivestire il pannello con lastre ceramiche o di altri materiali pesanti, con spessore fino a 6mm, senza alcuna difficoltà. Suit è lo strumento perfetto per il progettista che vuole dialogare con gli ambienti nelle sue più molteplici forme: la porta può essere integrata in una boiserie o installata nella muratura, a filo muro, utilizzando i più diversi materiali, dai legni ai vetri, alle ceramiche.

**Possibili applicazioni.**

La porta Suit è disponibile nella versione con stipite filomuro con cerniere nascoste, che permette un'integrazione quasi invisibile del pannello porta nella parete, con stipite filomuro bilico, caratterizzato da un sistema di rotazione traslato e infine bilico senza stipite, dove i pannelli ruotano sul proprio asse verticale, simmetrico o asimmetrico, senza elementi aggiunti.

**A system of flush doors with a high degree of configurability at the service of the designer.**

Suit is a door system characterized by an almost invisible aluminum frame that allows you to cover the panel with ceramic slabs or other heavy materials, with a thickness of up to 6mm, without any difficulty. Suit is the perfect tool for the designer who wants to dialogue with environments in its many forms: the door can be integrated into a boiserie or installed in the masonry, flush with the wall, using the most various materials, from wood to glass, to ceramics.

**Possible applications.**

The Suit door is available in the version with flush-to-the-wall jamb with hidden hinges, which allows an almost invisible integration of the door panel into the wall, with pivoting flush-to-the-wall jamb, characterized by an offset rotation system and finally pivoting without jamb, where the panels rotate on its own vertical axis, symmetrical or asymmetrical, without added elements.

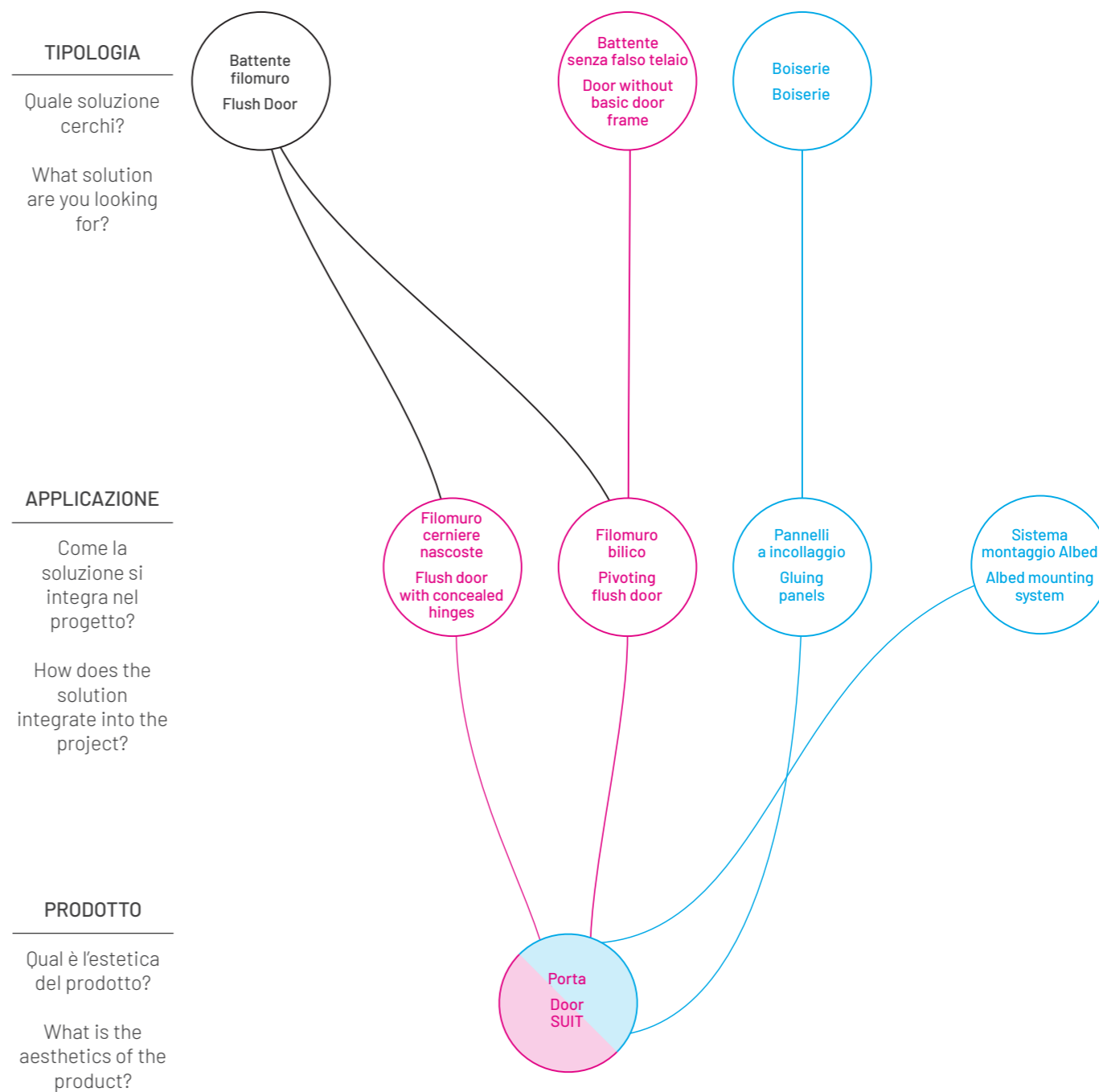

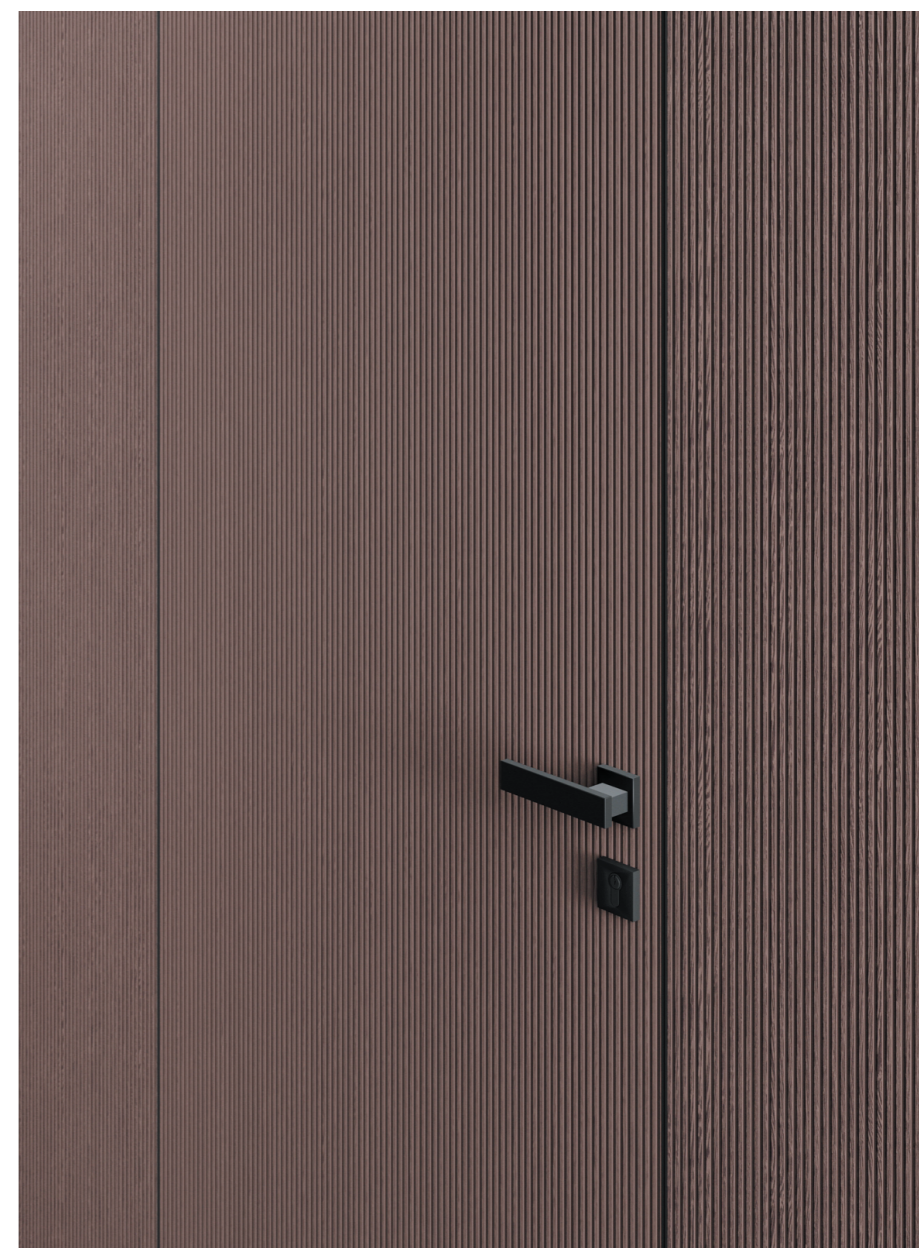

Lo stipite "filomuro con cerniere nascoste" per pannelli Suit con spessore 60mm, permette di realizzare la classica porta a filomuro, pressochè invisibile sulla parete. Questo stipite si distingue per un disegno della battuta fortemente raccordata privo di spigoli che garantisce risultati estetici inconsueti per porte di questo spessore.

The flush jamb "with concealed hinges jamb" for panels Suit of 60mm thickness, allows to realize the classic flush to the wall door, almost invisible on the wall. This jamb has a design that guarantees unusual aesthetic results for doors with this thickness.



Le cerniere a scomparsa sono incassate all'interno dello stipite e del pannello porta permettendo una completa coplanarietà tra porta e parete senza alcuna presenza visibile. L'effetto che si ottiene è di estrema pulizia. Albed utilizza cerniere certificate, regolabili sui 3 assi.

The concealed hinges are built-in the jamb and the door panel allowing complete coplanarity between door and wall without any visible presence. Albed uses certified hinges that can be adjusted on three axes.



La soluzione "bilico senza stipite" permette di realizzare porte minimali che dividono gli spazi architettonici senza alcun elemento aggiunto.

The pivoting solution without jamb allows to create minimal doors that divide the architectural spaces without any additional element.





I pannelli ruotano sul proprio asse verticale, simmetrico o asimmetrico, diventando essi stessi elementi progettuali architettonici.



The panels rotate on their vertical, symmetrical or asymmetrical axis, becoming themselves architectural design elements.



La combinazione tra stipite, attrezzato con cerniere ad alto carico, e il pannello Suit, permette di rivestire questa porta con materiali pesanti senza alcuna difficoltà e senza comprometterne le prestazioni tecniche.

The combination of jamb, equipped with invisible hinges with high performance in terms of capability, allows to cover this door with heavy materials without any difficulties and without compromising its technical performance.

Il sistema prodotto Albed

# UN SISTEMA COMPLETO DI SOLUZIONI TECNICHE AL SERVIZIO DEL PROGETTISTA.

Albed's product system

# A COMPLETE SYSTEM OF TECHNICAL SOLUTIONS, SERVING THE DESIGNER

Le soluzioni Suit del sistema prodotto Albed  
Albed's Product System solutions for Suit

Tipologia / Typology: Porta battente singola | Single hinged door

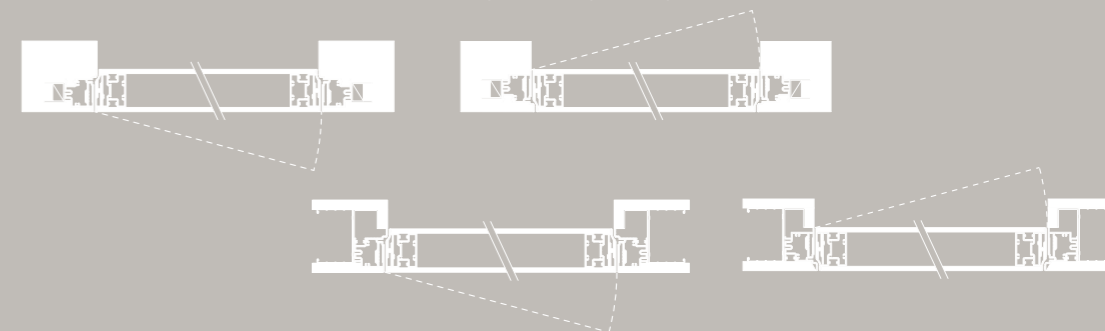

Tipologia / Typology: Porta battente doppia | Double hinged door

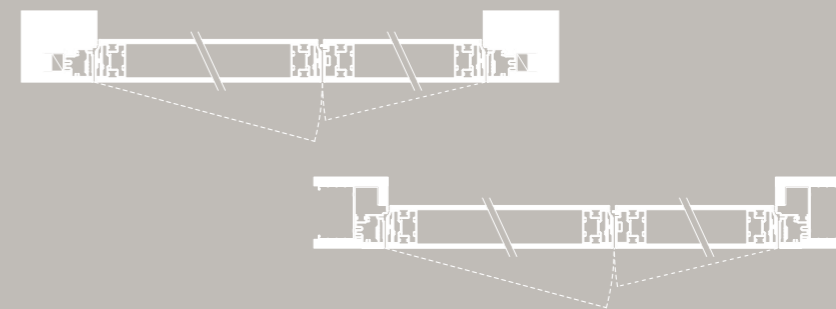

Tipologia / Typology: Porta battente bilico | Pivot door

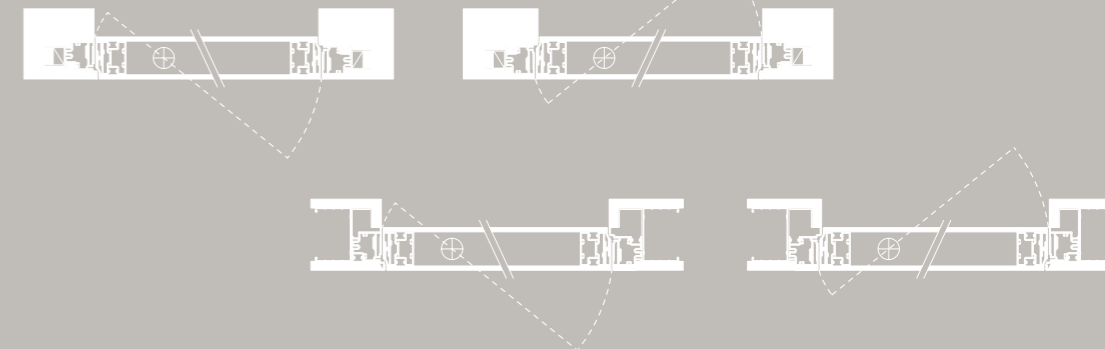

Tipologia / Typology: Porta bilico senza stipite | Pivot door without jamb

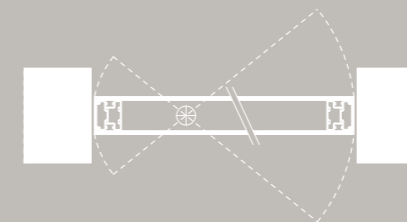

## Suit Porta battente singola | Single hinged door

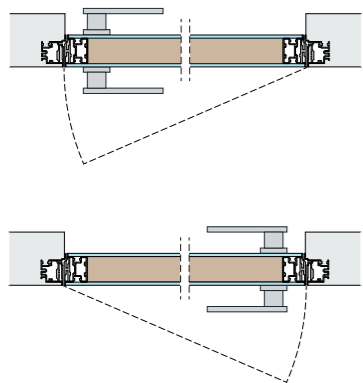

Tipologia / Tipology : Battente filomuro  
Flush hinged door  
Stipite / Jamb : Filomuro | Flush jamb  
Porta / Door : Porta battente singola  
Single Hinged door



Installazione a filo su pareti di cartongesso o muratura.  
Dimensione massima battente mm. 1000 x 3000.

Flush installation on plasterboard or bricks.  
Maximum size mm. 1000 x 3000

## Suit Porta battente doppia | Double hinged door

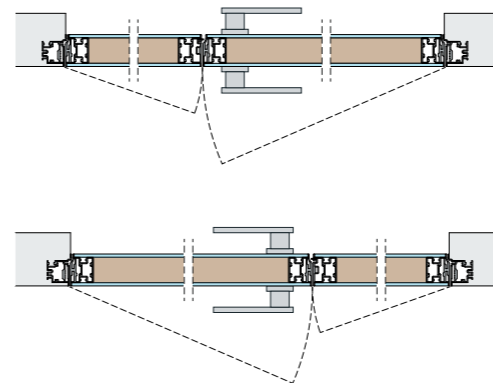

Tipologia / Tipology : Battente Filomuro  
Fush hinged door  
Stipite / Jamb : Filomuro | Flush jamb  
Porta / Door : Porta battente doppia  
Double hinged door



Installazione su cartongesso o muratura. Porta battente a due ante asimmetriche (disponibile anche nella versione a due ante simmetriche). Dimensione massima mm. 2000 x 3000.

Installation on plasterboard or bricks. Double asymmetrical hinged door (available also in the symmetrical version).  
Maximum size mm. 2000 x 3000.

## Suit Porta a bilico con battuta | Pivoting flush door

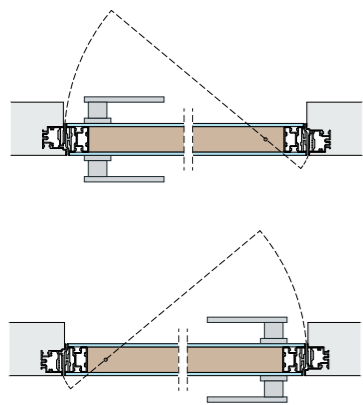

Tipologia / Typology : Bilico filomuro  
Flush pivoting door  
Stipite / Jamb : Filomuro | Flush jamb  
Porta / Door : Porta battente singola  
Single Hinged door

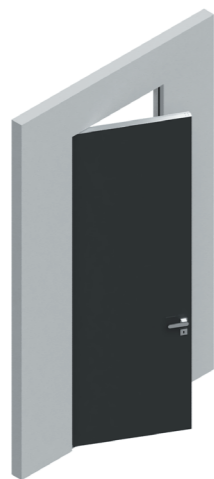

Installazione a filo su pareti di cartongesso o muratura.  
Dimensione massima battente mm. 1000 x 3000.

Flush installation on plasterboard or bricks.  
Maximum size mm. 1000 x 3000.

## Suit Porta a bilico senza stipite | Pivot door without jamb

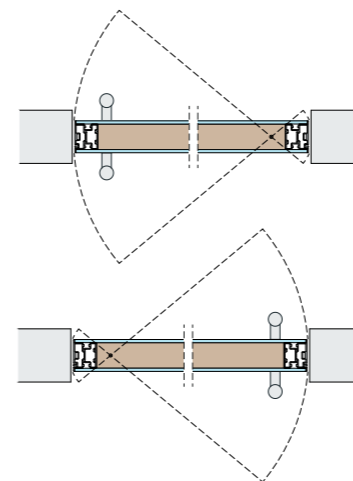

Tipologia / Typology : Bilico senza stipiti  
Pivoting without jambs  
Stipite / Jamb : Senza stipite | Without jamb  
Porta / Door : Porta bilico singola  
Single pivot door



Installazione senza stipiti. Misura massima  
mm. 1200 x 3000.

Installation without jambs. Maximum sizes mm. 1200 x 3000.

## Boiserie con pannelli a incollaggio / Boiserie with gluing panels

Pannelli incollati su parete / Panels glued to the wall

Il sistema Boiserie Albed ad incollaggio è un sistema di rivestimento a parete fisso che favorisce il contenimento degli spessori, pur garantendo stabilità, isolamento acustico e termico e integrazione con una vasta gamma di stipiti e porte filomuro o effetto filomuro. La sezione di 18mm progettata da Albed si compone di pannelli di supporto, anche certificati FSC, e una gamma variabile di vetri e finiture nobili in legno per soddisfare le diverse esigenze dell'interior design, dal mondo residenziale a quello dell'ospitalità e del mondo professionale.

Albed gluing System is a fixed wall covering system that supports the containment of thicknesses, while ensuring stability, sound and thermal insulation and integration with a wide range of jambs and flush doors or flush effect doors. The 18mm section designed by Albed consists of support panels, also FSC certified, and a variable range of glasses and noble wood finishings to meet the different requirements of the interior design, from the residential to the hospitality world and to the professional world.

### Componenti / Components

#### BOISERIE A INCOLLAGGIO / BOISERIE GLUING

1. Modulo boiserie vetro / Glass boiserie module;
2. Modulo boiserie legno / Wooden boiserie module;

#### PORTE / DOORS

3. Porta singola filomuro cerniere nascoste, Next 50mm telaio alluminio, a tirare, apertura a sinistra / Single flush door with concealed hinges, Next 50mm aluminium frame, to pull, left opening;
4. Porta singola filomuro cerniere nascoste, Next 58mm pannello legno, a spingere, apertura a destra / Single flush door with concealed hinges, Next 58mm wooden panel, to push, right opening;
5. Porta singola filomuro cerniere nascoste, Suit con rivestimento in legno, a tirare, apertura a sinistra / Single flush door with concealed hinges, Suit with wooden coating, to pull, left opening;
6. Porta singola effetto filomuro, Level pannello legno, a tirare, apertura a destra / Single flush-effect door, Level wooden panel, to pull, right opening.

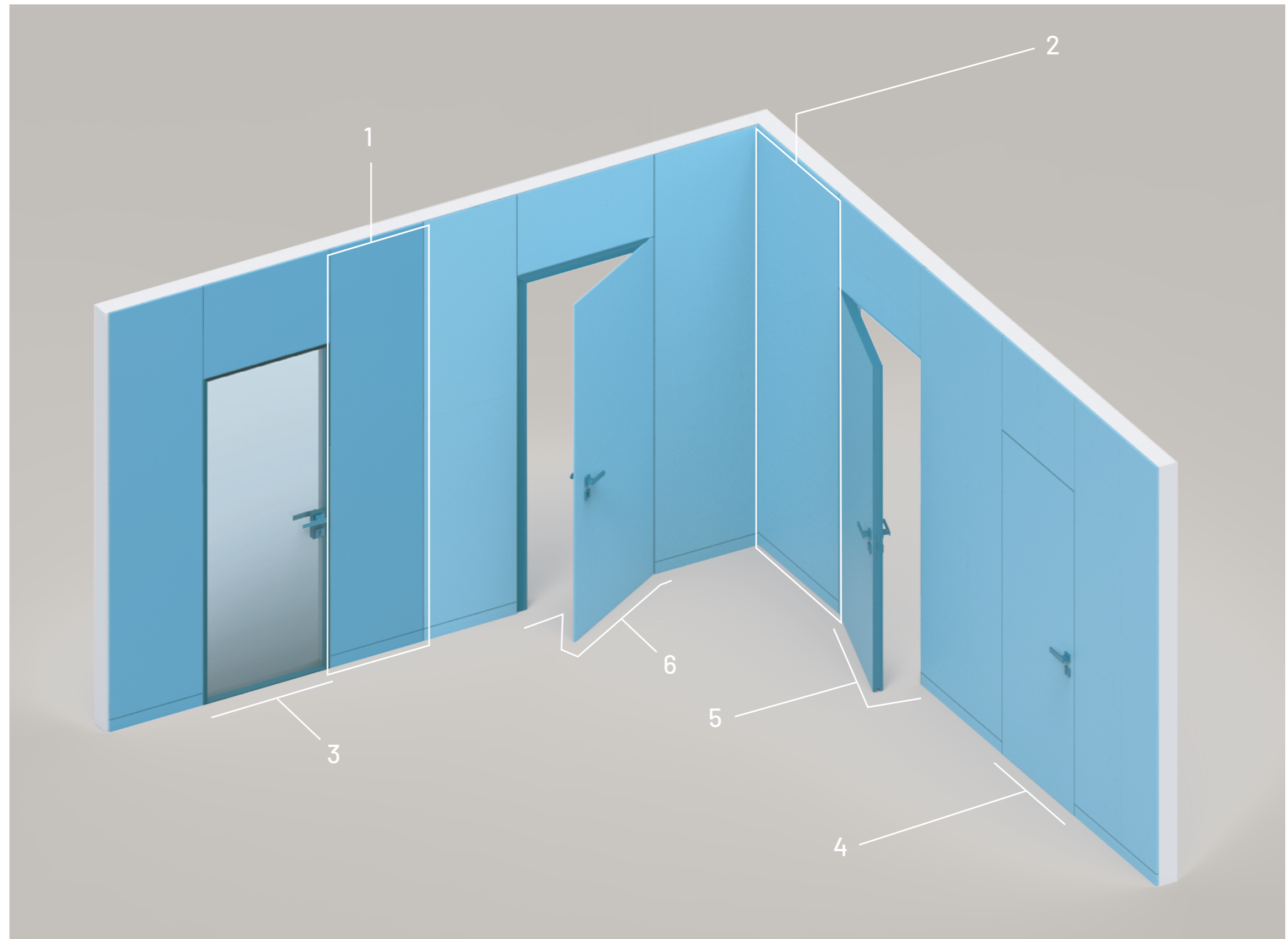

## Boiserie sistema a montaggio Albed / Boiserie Albed mounting system

Pannelli montati su struttura / Panels mounted on structure

Il sistema Boiserie Albed a montaggio è un sistema di rivestimento a parete removibile che favorisce una gestione dinamica degli spazi, rendendo tutti i pannelli removibili in pochi secondi, grazie ad un sistema di agganci stabile, semplice e affidabile. Questo sistema permette di installare boiserie in vetro, legno e ceramica completamente removibili e ispezionabili con una sezione di soli 30mm dalla parete di appoggio. La Boiserie Albed incrementa l'isolamento acustico e termico ed è integrabile con una vasta gamma di stipiti e porte filomuro o effetto filomuro. I pannelli di supporto possono essere certificati FSC e si accompagnano ad una vasta gamma di vetri, finiture nobili in legno o lastre ceramiche fornite dal cliente per soddisfare le diverse esigenze dell'interior design, dal mondo residenziale a quello dell'ospitalità e del mondo professionale.

Albed mounting System is a removable wall covering system that supports a dynamic management of spaces, making the panels removable in few seconds, thanks to a stable, easy and reliable hooking system. This system allows to install glass, wood and ceramic boiserie which are completely removable and inspectable with a section of only 30 mm from the support wall. Albed Boiserie increases sound and thermal insulation and can be integrated with a wide range of jambs, flush doors or flush effect doors. The support panels can be FSC certified and can be matched to a wide range of glasses and noble wood finishings or ceramic slabs provided by the customer to meet the different requirements of interior design, from the residential to the hospitality world and to the professional world.

### Componenti / Components

#### BOISERIE A MONTAGGIO / BOISERIE MOUNTING SYSTEM

1. Modulo boiserie vetro o ceramica / Glass or ceramic boiserie module;
2. Modulo boiserie legno / Wooden boiserie module;

#### PORTE / DOORS

3. Porta doppia simmetrica filomuro cerniere nascoste, Suit con rivestimento in vetro o ceramica, a tirare, anta principale sinistra / Double symmetrical flush door with concealed hinges, Suit with glass or ceramic coating, to pull, left main door;
4. Porta singola filomuro bilico, Suit con rivestimento legno, a tirare, apertura a destra / Single pivoting flush door, Suit with wooden coating, to pull, right opening;
5. Porta singola effetto filomuro bilico, Boisè pannello legno, a spingere, apertura a sinistra / Single pivoting flush-effect door, wooden panel, to push, left opening.

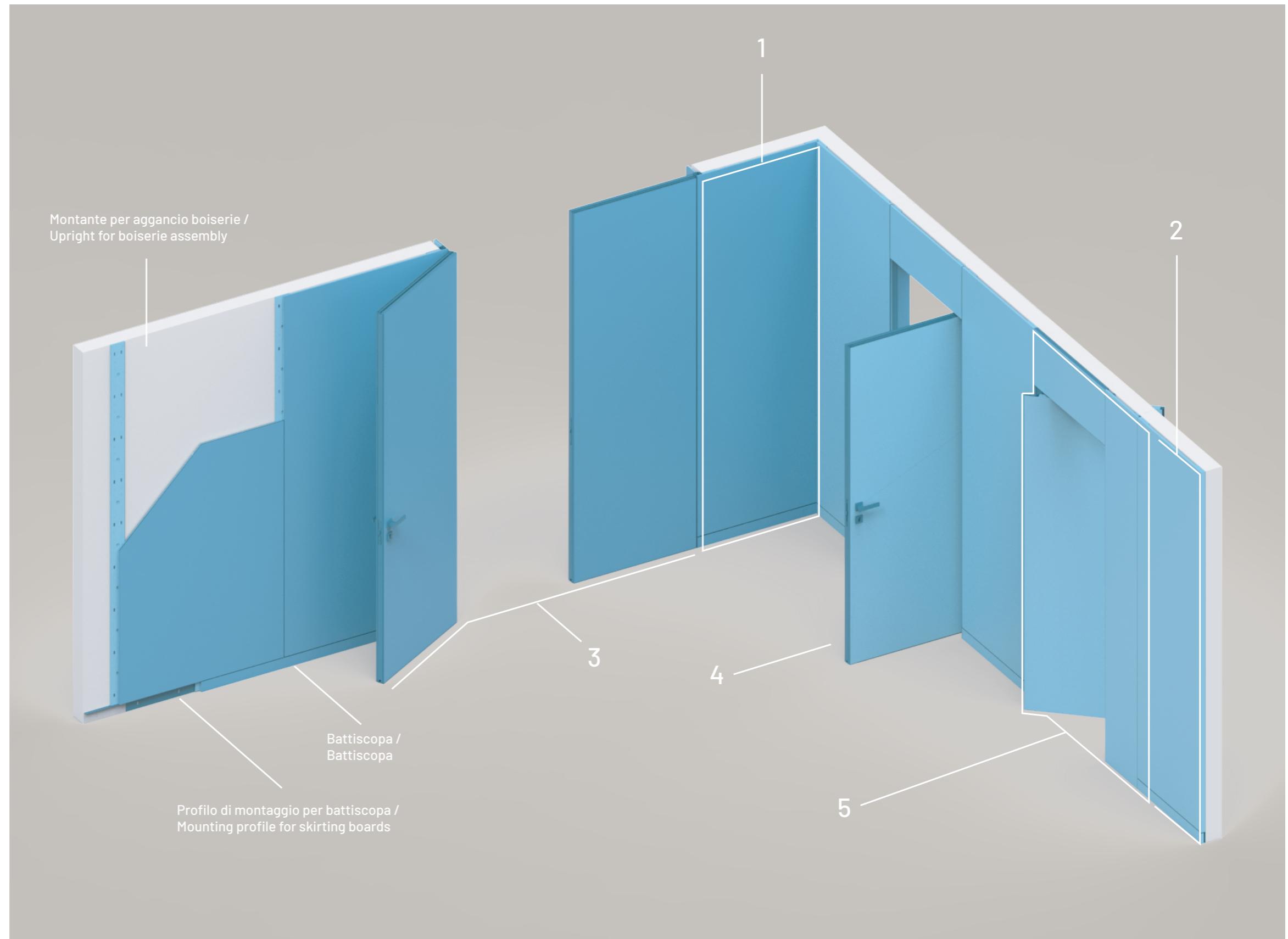

# Finiture / Finishing

## Stipite e telaio porta / Jamb and door frame:

### ALLUMINIO ANODIZZATO / ANODIZED ALUMINUM

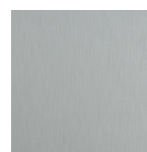

AA - ALLUMINIO

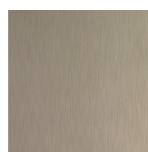

AC - CHAMPAGNE



AO - ORO



AB - BRONZO



AT - TITANIO



AN - NERO

## Pannello porta in vetro / Glass door panel:

### VETRI TRASLUCIDI SATINATI / TRANSLUCENT SATIN GLASSES



11 - NEUTRO ACIDATO



65 - NEUTRO EXTRA-CHIARO ACIDATO



12 - BIANCO LATTE



16 - FUMÈ ACIDATO



18 - BRONZO ACIDATO



6A - GOLD ACIDATO

### VETRI TRASLUCIDI RIFLETTENTI / REFLECTIVE GLASSES



94 - NEUTRO REFLEX

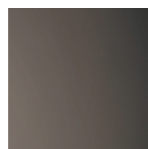

92 - SMOCKED REFLEX



93 - BRONZE REFLEX



63 - DARK GREY



7A - GOLD REFLEX

### VETRI TRASLUCIDI LAVORATI / TRANSLUCENT STRUCTURED GLASSES



LACCATO RAL

### VETRI A SPECCHIO / MIRRORS



40 - SPECCHIO



37 - SPECCHIO BRONZO

### VETRI RETROLACCATI LUCIDI / GLOSSY PAINTED GLASSES



53 - BIANCO NEVE EXTRACHIARO



72 - POLVERE



38 - TORTORA



20 - QUARZO



48 - NERO



9A - BEIGE



1B - GRIGIO LONDRA

### VETRI RETROLACCATI SATINATI / PAINTED SATIN GLASSES



51 - BIANCO NEVE EXTRACHIARO SAT.



74 - POLVERE SATINATO



67 - TORTORA SATINATO



21 - QUARZO SATINATO



69 - NERO SATINATO



3B - BEIGE SATINATO



4B - GRIGIO LONDRA SATINATO



5A - CENERE SATINATO



5B - GRIGIO GOTHAM SATINATO

## Pannello porta in legno / Wooden door panel:

### LACCATURA PANNELLI / LAQUERED PANELS



LACCATO RAL

### RIVESTIMENTO IN LEGNO / WOOD VENEERED



RC - ROVERE CHIARO



RD - ROVERE DECAPÉ



RM - ROVERE MIELE

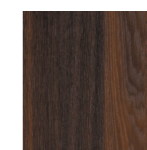

RT - ROVERE TERMOTRATTATO

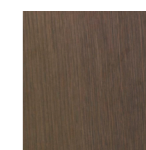

RN - ROVERE NOTTE



FN - FRASSINO NEVE

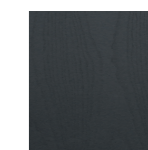

FC - FRASSINO CARBONE

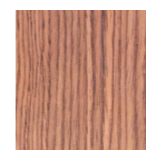

NC - NOCE CANALETTO

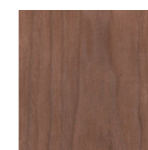

NT - NOCE TABACCO

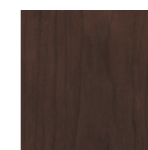

NM - NOCE MOKA

## Suit

/ **Suit:** un prodotto di Albed  
/ **Design:** CRS Albed  
/ **Art direction / Graphic design:** Luca Bossi

### / Albed

Siamo un'azienda produttiva con un dna metalmeccanico legato alla lavorazione dell'alluminio dove le competenze tecniche diventano strategiche per assicurare un servizio al progetto affidabile e di qualità. Un brand che fa del design, dell'esclusività e della cura del dettaglio il suo carattere distintivo e che grazie ad un team organizzato, collaborativo e dinamico sviluppa soluzioni funzionali al progetto.

Nell'ottica di un continuo sviluppo del prodotto, la ditta si riserva il diritto di cambiare specifiche, design e materiali in qualsiasi momento e senza preavviso. I colori evidenziati hanno il solo scopo illustrativo e sono tanto accurati quanto il processo di stampa può permettere.

With the aim of a continuous product development, the company reserves the right to change specifications, design and materials at any time and without notice. The colours shown are for illustrative purposes only and they are as accurate as the printing process can permit.

### / Albed

In essence, we are an engineering company that works with aluminium, in which technical skills become strategic for ensuring reliable, high quality service for any project. This brand makes design, exclusivity, and attention to detail its distinctive character and, thanks to a well organised, collaborative and dynamic team, we develop solutions to suit the project.



La tua soluzione  
online su [albed.it](http://albed.it)

**ALBED**  
MILANO 1964

ALBED - Delmonte Srl  
via San Martino  
Nova Milanese - (MB)  
t. +39 0362 367112  
info@albed.it  
www.albed.it

ALBED flagship store  
via Gonzaga 7 - Milano (MI)  
t. +39 02 76340610  
milano@albed.it

**ALBED**

M I L A N O 1 9 6 4

ALBED - Delmonte Srl  
via San Martino  
Nova Milanese - (MB)  
t. +39 0362 367112  
info@albed.it  
www.albed.it

ALBED flagship store  
via Gonzaga 7 - Milano (MI)  
t. +39 02 76340610  
milano@albed.it